



SAMSUNG Video Wall Kit Installation Guide



Contents

English

1. Product Overview	1	Product Feature
	2	Package Contents
	3	Part Names
2. Installation	4	Installation Instructions
	4	Adjusting the Level
	6	Arranging the Stand
	6	Assembling the Monitor
	10	Connecting and Arranging the Cables
3. Fixing	11	Fixing the monitor to the wall
4. Various Installation Methods	12	Basic (3x3)
	12	Stair
	12	Pyramid
	12	Circular
	13	Rectangle
5. Product Specifications (Drawing)		

1.Product Overview









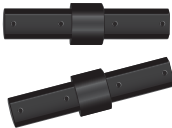

Product Feature

- Samsung ID 1 (MID40, MID46) : compatible with 400UX(n), 460UX(n) series
- Samsung ID 2 (MID462) : compatible with 460UT(n) series
- Interlocking Display Solution
- Multi LCD Display Solution
- Free Standing Solution
- Easy Content Management
- 4-Layer stackable

Package Contents



SAMSUNG Video Wall Kit Main Body Front View / Back View

		
<p>BRACKET-BALLAST Quantity: 5EA</p>	<p>BRKT-LINK MIDDLE Quantity: 8EA</p>	<p>BRACKET-LINK TOP Quantity: 2EA</p>
		
<p>Screws (M5 x L12) Quantity: 40EA</p>	<p>Screws (M6 x L15) Quantity: 5EA</p>	<p>Screws (M4 x L10) Quantity: 50EA</p>
		
<p>HOLDER WIER Quantity: 10EA</p>	<p>Spanner</p>	<p>Hinge</p>
		
<p>L-Shape Wrench (4mm) Quantity: 1EA</p>	<p>BRKT-COVER Quantity: 8EA</p>	

Part Names

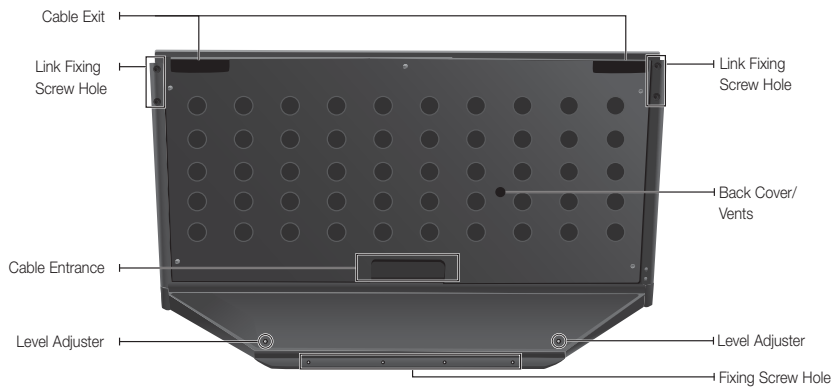
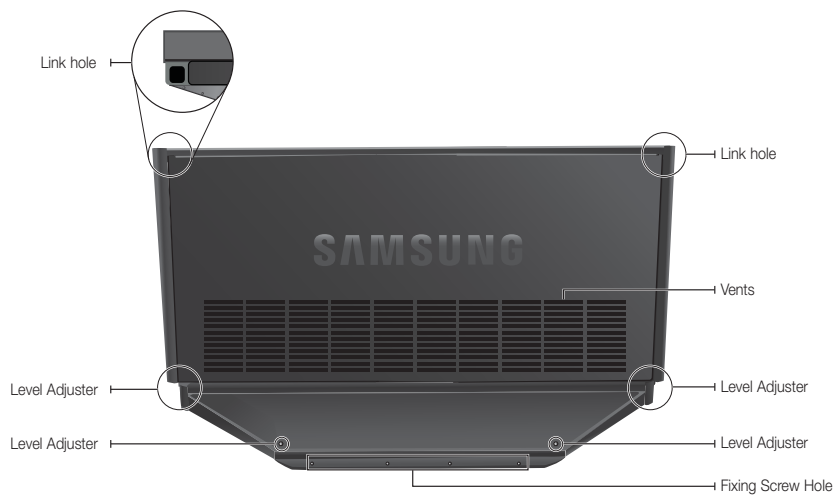

2. Installation

Installation Instructions

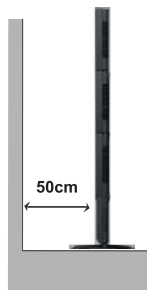

- Install the product maintaining a distance of at least 50 cm from the wall.
- Make sure to fix the product to the floor with screws.

1

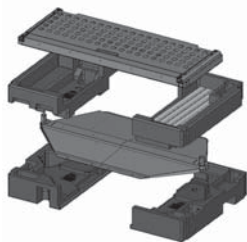

2

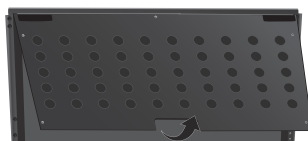

3

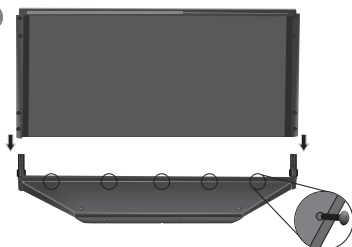

4



- When the assembly is complete, arrange the cables on the back of the stand, close the rear cover and fasten the screws(M6 X L15).



- Assemble the cover rear with the brkt-cover using the screw(M4 X L10), Each brkt-cover needs 3 screws.

Adjusting the Level

1. Place the product on a flat surface (floor).
2. Level the product using the 4 Level Adjusters at the front and back of the product using the L-shape wrench.

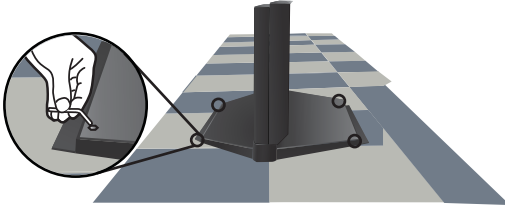

3. Level the product by turning the 2 Level Adjusters on both sides of the product.

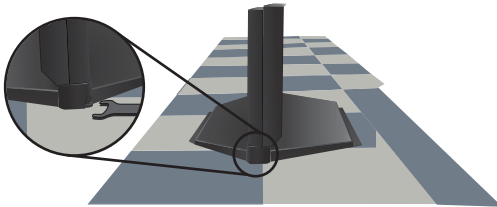

4. You must level the product using the level gauge spirit level so that the angles of the sides and the top are within a range of 89.8~90.2 degrees.

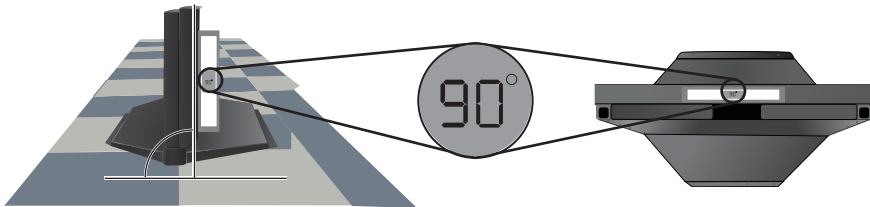

- If the vertical angle is not within the 89.8~90.2 degree range, the monitors may fall when they are piled up. Ensure that the angle is within the range.

Arranging the Stand

- Arrange the stand in the installation shape.
(Level each of the stands referring to the descriptions in the “Adjusting Level” section.)



- If you want the monitor inclined towards you, tilt it as far as you need it to go and fix it on the floor. Assemble it following the same steps described previously.

Assembling the Monitor

- ☑ After stacking the necessary monitors on top of each other and fastening all the screws to the connecting parts.
To stack 3 or more monitors, two or more persons must work together.

1. Insert the Middle Bracket-Links into the connecting pipe.

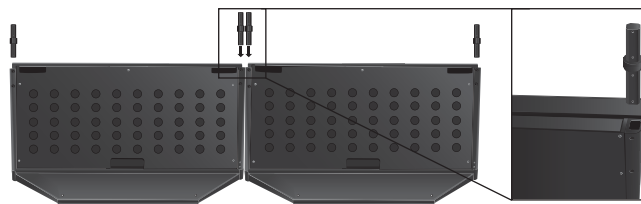

2. Assemble the Ballast-Brackets.

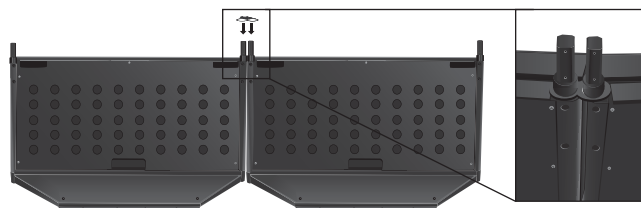

3. Assemble the monitors.

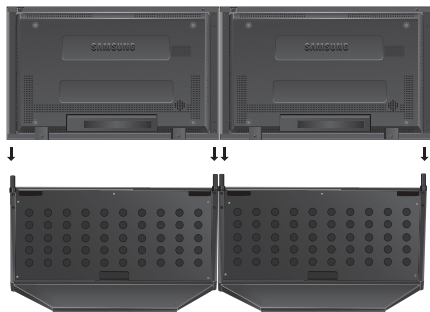

4. After assembling the monitors, assemble the Middle Bracket-Links and Ballast-Brackets.



5. After assembling the Middle Bracket-Links and the Ballast-Brackets, assemble the monitors.



6. Assemble all the monitors (up to 4 monitors in a column) according to the same procedures, install the Top Bracket-Link, and then fasten all the screws of the connecting parts.

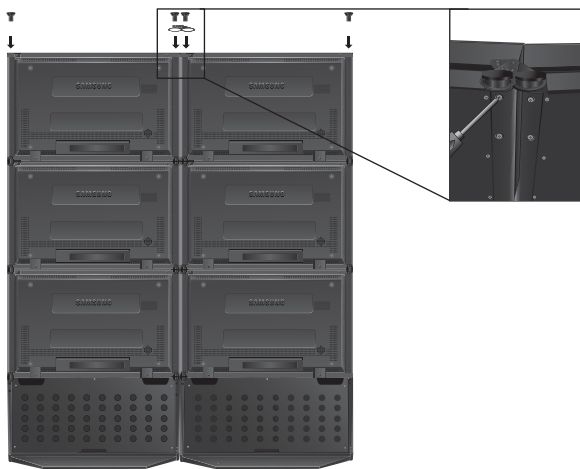

7. When the arrangement is complete, fix it to the floor with the screws.



- ☑ The parts used for the product assembly are as follows.
ex) When monitors are constructed in a 2x3 stack.

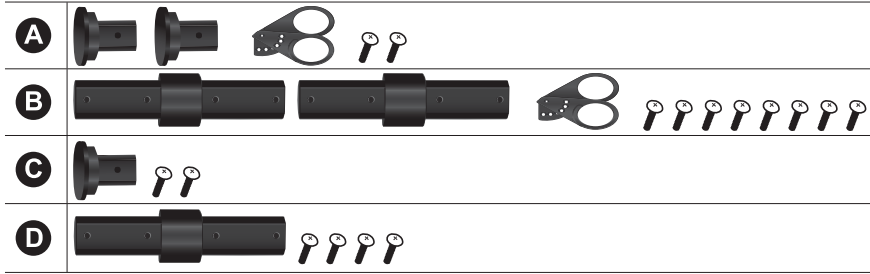
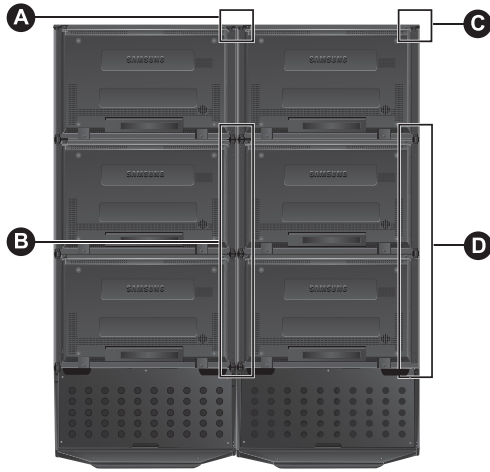

Connecting and Arranging the Cables

1. Remove the 6 screws from the back of the product and separate the back cover.



2. Arrange the cables and hubs in the arrangement space and close the cover.
3. Connect the cables with the relevant devices.
4. Tie the cables firmly using the arrangement hook at the back of each monitor.

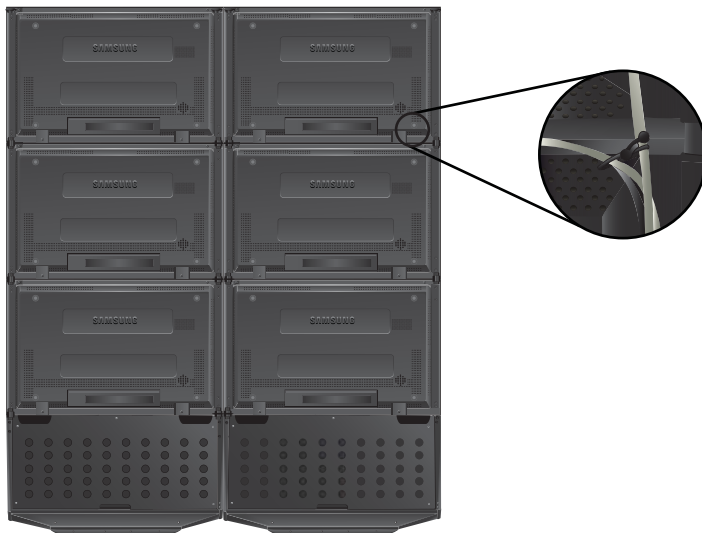

5. If the number of stacked monitors in a column is equal to or greater than 3, the power cable may be too short. In this case, connect the power using a power extension cable.



Power Extension Cable (Optional)

3. Fixing

Fixing the monitor to the wall

If the monitor is not fixed to the wall, movement of up to ± 1 degrees at the front and back may occur. Therefore, make sure to fix the monitor to the wall using the Top-Bracket.

☑ Create a fixing pipe referring to the specifications of the Top-Bracket on the "Product Specifications" page.

[Required Parts]

- A Wall-Fixing Pipe with a 30mm size (to be created separately.)

- Fixing Screws

1. After installing the product, connect the Top-Bracket to the top part of the Top-Bracket-Link.

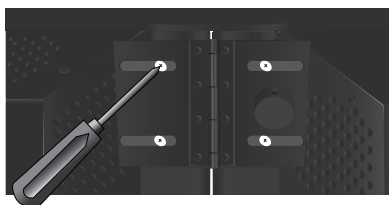

2. Insert the prepared fixing pipe into the Top-Bracket.

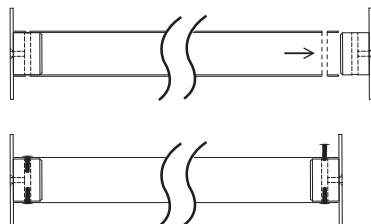

3. Check the position of the wall and fix the Top-Bracket to the wall using the screws and fix the product to the wall.

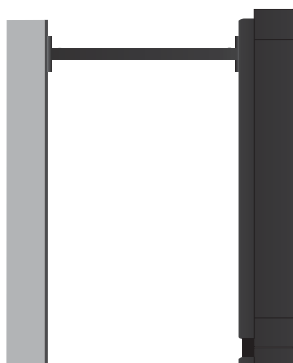

Note: Maintain a distance of at least 50cm from the wall.

4. Various Installation Methods

Basic (3x3)



Stair



Pyramid



Circular



Back of the Folding

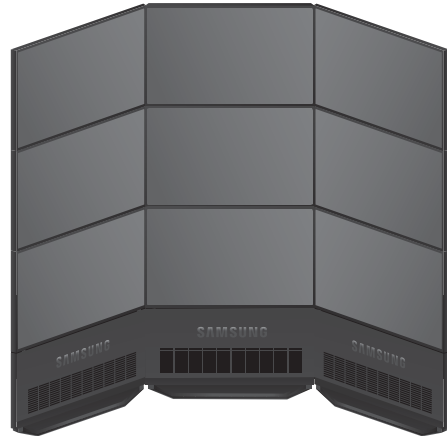

Front of the Folding

Rectangle



Note: If monitors are assembled in the shape of a rectangle, maintain a space of at least 30cm from the ceiling as air may become trapped inside and result in overheating.

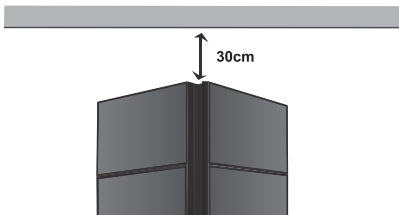

5. Product Specifications (Drawing)

For 40 Inch Monitors Samsung ID 1

1. Weight
 - Net : 29.0kg
 - Gross : 45.0kg

2. Size

	Width[mm]	Depth[mm]	Height[mm]
Set	913.7	600	468
Packing Dimension	1030	696	361

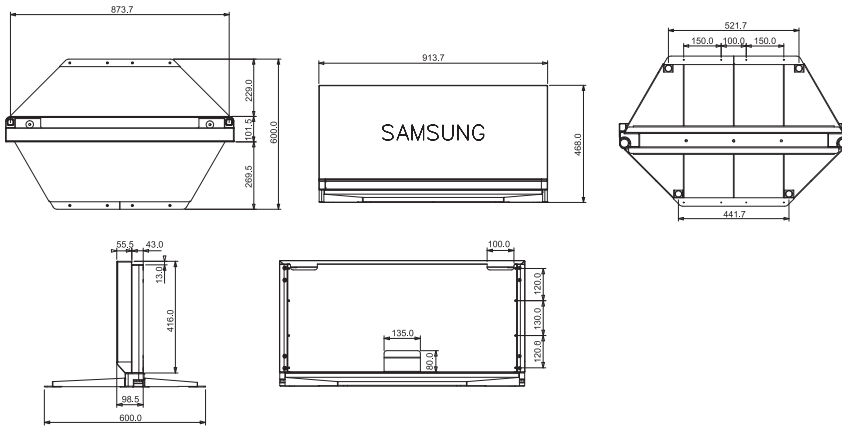

For 46 Inch Monitors Samsung ID 1

1. Weight
 - Net : 33.0kg
 - Gross : 51.0kg

2. Size

	Width[mm]	Depth[mm]	Height[mm]
Set	1049.4	600	468
Packing Dimension	1166	696	361

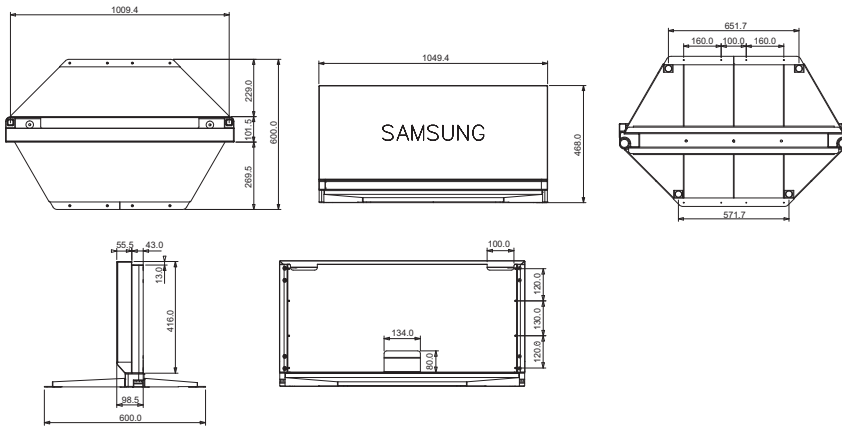

For 46 Inch Monitors Samsung ID 2

- 1. Weight
 - Net : 40.0Kg
 - Gross : 52.0Kg

2. Size

	Width[mm]	Depth[mm]	Height[mm]
Set	1025.5	600	467
Packing Dimension	1121	696	361

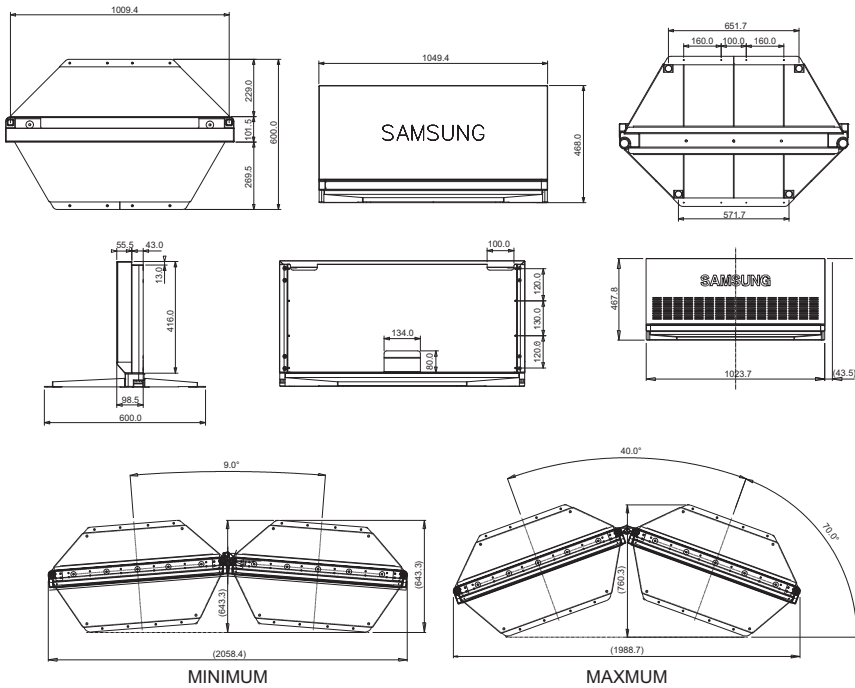

BRACKET-LINK MIDDLE

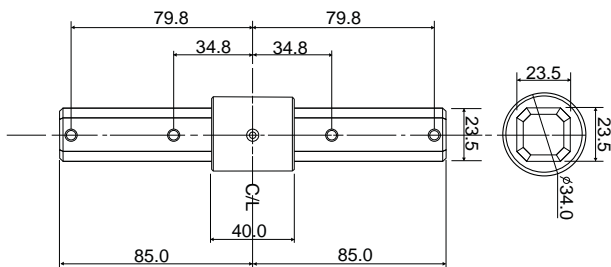

BRACKET-TOP

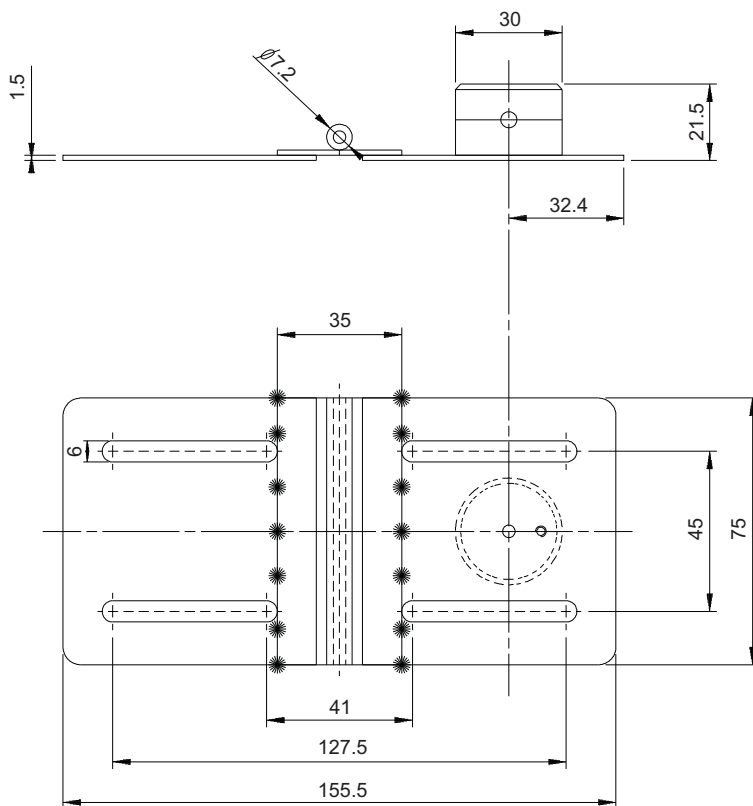

BRACKET-LINK

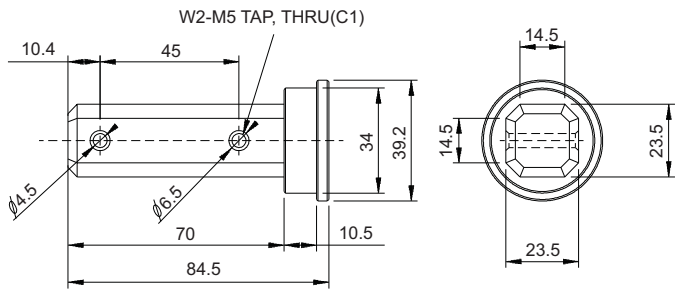

BRACKET-BALLAST

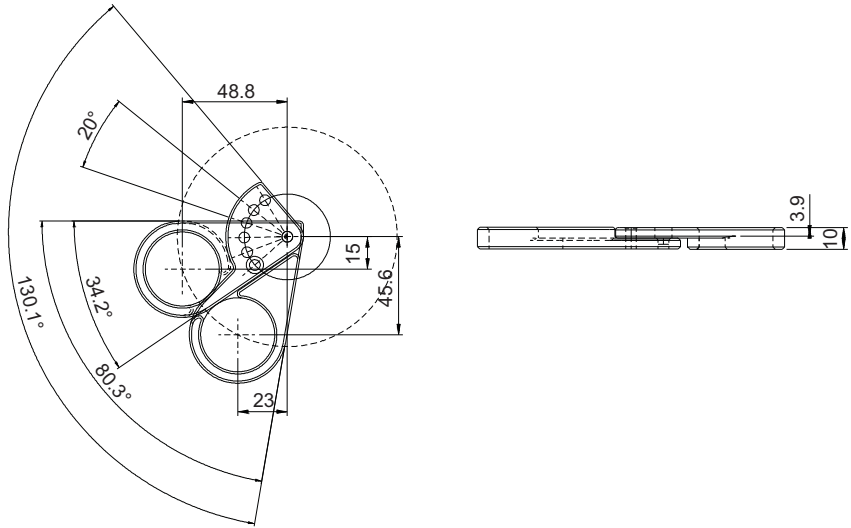

BRKT-COVER (MID 40)

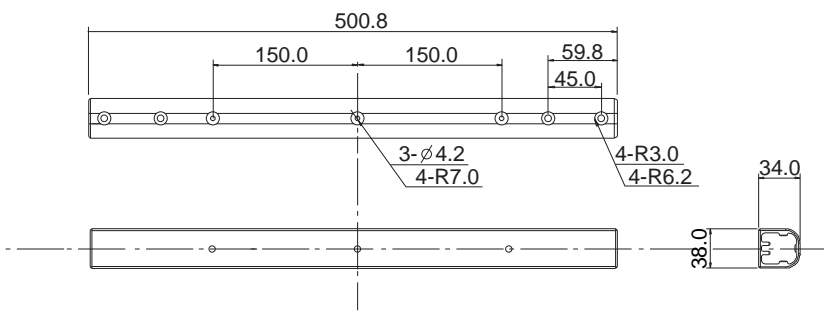

BRKT-COVER (MID 46)

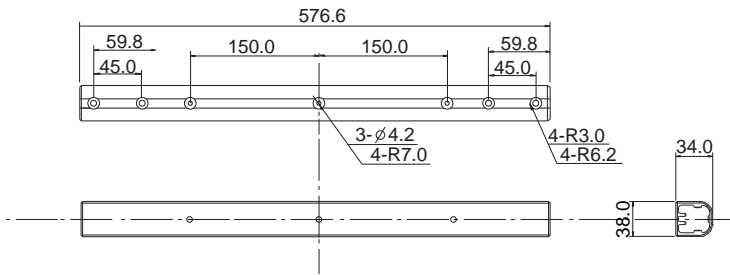

BRKT-COVER (MID 462)

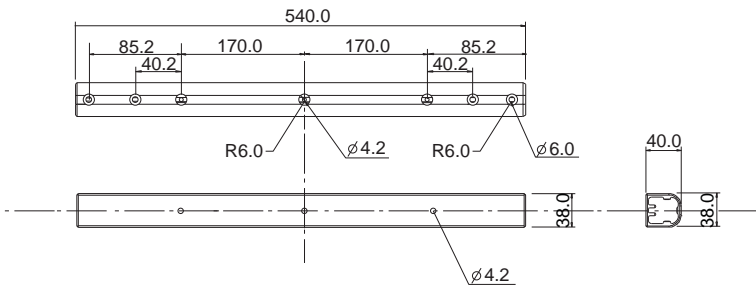



Contact SAMSUNG WORLDWIDE

If you have any questions or comments relating to Samsung products,
please contact the SAMSUNG customer care centre.